

DEVANTI

Dishwasher

Instruction Manual

BDW-6-02A-SI

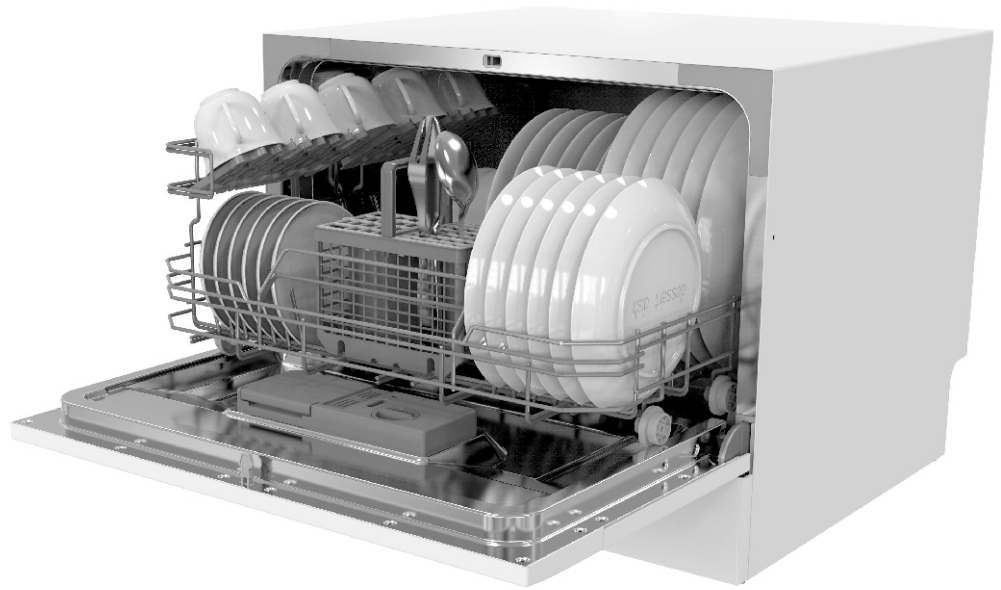

Quick Operation Guide

For detailed operating method read the corresponding content on the instruction manual.

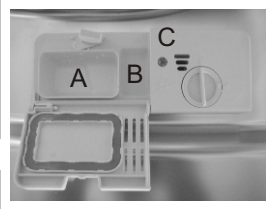
Switch on the appliance	Press the Power switch button to switch on the appliance, Open the door.
Fill the detergent dispenser	<p>Compartment A: For each wash cycle.</p> <p>Compartment B: For programs with pre-wash only. (Follow the user instructions)</p> 
Check the rinse aid level	<p>Mechanical indicator C. Electric indicator on control panel (if provided).</p>
Load the baskets	Scrape off any large food particles. Soften remnants of burnt food in pans, then load the baskets. Refer to the dishwasher loading instructions.
Select a programme	Close the door, Press the program button until the selected program lights up. (See the section entitled "Operation instruction")
Running the dishwasher	Turn on the water tap and press the Start/Pause button. The machine will start working after about 10 seconds.
⋮	
<ul style="list-style-type: none"> Changing the programme 	<ul style="list-style-type: none"> 1. A running cycle can only be modified if it has been running for a short time. Otherwise the detergent may have already been released and the water already drained. If in this case, the detergent dispenser must be refilled. 2. Press Start/Pause Button the machine will be in stand by state ,then press the Program Button more than 3 seconds to cancel the currently Program. 3. Select a new program. 4. Restart the dishwasher.
<ul style="list-style-type: none"> Add forgotten dishes in the dishwasher. 	<ul style="list-style-type: none"> 1.Press the Start/Pause button to stop the machine. 2.Open the door. 3.Add the forgotten dishes. 4.Close the door, then press the Start/Pause button, the dishwasher will start running again after 10 seconds.
<ul style="list-style-type: none"> If the appliance is switched off during a wash cycle. 	<ul style="list-style-type: none"> If the appliance was switched off during a wash cycle, when switch on again, please re-select the washing cycle and operate the dishwasher from the beginning.
⋮	
Switch off the appliance	When the working cycle is finished, the buzzer of the dishwasher will sound 8 times, then stop. Turn off the appliance using the Power button. Since the appliance is standing by, it will power off automatically after 30 minutes without any operation.
Turn off the water tap, unload the baskets	Warning: wait a few minutes (about 15 minutes) before unloading the dishwasher to avoid scald, as the dishes and utensils are still hot and more susceptible to break. They also could dry better.

⚠ WARNING!
Open the door carefully. Hot steam may escape when the door is opened!



Read this Manual

Dear Customer,

- Please carefully read this manual before using the dishwasher, it will help you to use and maintain the dishwasher properly.
- Keep it for reference in future.
- Pass it on to any subsequent owner of the appliance.

This manual contains sections on safety Instructions, Operating Instructions, Installation Instructions and Troubleshooting Tips etc.



Before Mailing for Service

- To review the section on troubleshooting Tips will help you to solve some common problems by yourself .
- If you can not solve the problems by yourself, please ask for the help from professional technicians.

NOTE:

- The manufacturer, following a policy of constant development and updating of the product, may make modifications without giving prior notice.
- This user manual shall also be got from the manufacturer or responsible vendor.

1) Safety Information.....	1
2) Disposal.....	2
3) Operation Instruction.....	3
Control Panel.....	3
Dishwasher Features.....	3
4) Prior to using for the first time.....	4
A. Rinse Aid Dispenser.....	4
B. Detergent	5
5) Loading the Dishwasher Basket.....	7
Attention before or after loading the Dishwasher Baskets.....	7
Loading the Basket.....	8
Cutlery Basket.....	8
6) Starting a washing programme.....	9
Wash Cycle Table.....	9
Turning on the Appliance.....	9
Change the Programme.....	10
At the end of the Wash Cycle.....	10
7) Maintenance and cleaning.....	11
Filtering System.....	11
Caring for the Dishwasher.....	12
8) Installation instruction.....	13
Positioning the Appliance.....	14
About Power Connection.....	14
Water Connection.....	14
Connection of Drain Hoses.....	15
Start of dishwasher.....	16
9) Troubleshooting Tips.....	17
Before mailing for service.....	17
Error codes.....	18
Technical information.....	19

1. IMPORTANT SAFETY INFORMATION



WARNING! When using your dishwasher, follow the precautions listed below:

- This appliance is intended to be used in household and similar applications such as:
 - staff kitchen areas in shops, offices and other working environments;
 - farm houses;
 - by clients in hotels, motels and other residential type environments;
 - bed and breakfast type environments.
- This appliance can be used by children aged from 8 years and above and persons with reduced physical, sensory or mental capabilities or lack of experience and knowledge if they have been given supervision or instruction concerning use of the appliance in a safe way and understand the hazards involved. Children shall not play with the appliance. Cleaning and user maintenance shall not be made by children without supervision. (For EN60335-1)
- This appliance is not intended for use by persons (including children) with reduced physical, sensory or mental capabilities, or lack of experience and knowledge, unless they have been given supervision or instruction concerning use of the appliance by a person responsible for their safety. (For IEC60335-1)
- This appliance is for indoor use only, for household use only. To protect against the risk of electrical shock, do not immerse the unit, cord or plug in water or other liquid.
- Please unplug before cleaning and maintenance the appliance. Use a soft cloth moisten with mild soap, and then use a dry cloth to wipe it again.



EARTHING INSTRUCTIONS

- This appliance must be earthed. In the event of a malfunction or breakdown, earthing will reduce the risk of an electric shock by providing a path of least resistance of electric current. This appliance is equipped with a cord having an equipment-earthing conductor and a earthing plug.
- The plug must be plugged into an appropriate outlet that is installed and earthed in accordance with all local codes and ordinances.
- Improper connection of the equipment-earthing conductor can result in the risk of an electric shock. Check with a qualified electrician or service representative if you are in doubt whether the appliance is properly earthed.
- Do not modify the plug provided with the appliance; If it does not fit the outlet. Have a proper outlet installed by a qualified electrician.

- Do not abuse, sit on, or stand on the door or dish rack of the dishwasher.
- Do not operate your dishwasher unless all enclosure panels are properly in place.
- Open the door very carefully if the dishwasher is operating, there is a risk of water squirting out.
- Do not place any heavy objects on or stand on the door when it is open. The appliance could tip forward.
- When loading items to be washed:
 - 1) Locate sharp items so that they are not likely to damage the door seal;
 - 2) Warning: Knives and other utensils with sharp points must be loaded in the basket with their points down or placed in a horizontal position.
- Check that the detergent powder is empty after completion of the wash cycle.
- Do not wash plastic items unless they are marked dishwasher safe or the equivalent. For plastic items not so marked, check the manufacturer's recommendations.
- Use only detergent and rinse additives designed for an automatic dishwasher.
- Never use soap, laundry detergent, or hand washing detergent in your dishwasher.
- Children should be supervised to ensure that they do not play with the appliance.
- The door should not be left open, since this could increase the risk of tripping.
- If the supply cord is damaged, it must be replaced by the manufacturer or its service agent or a similarly qualified person in order to avoid a hazard.
- During installation, the power supply must not be excessively or dangerously bent or flattened.
- Do not tamper with controls.
- The appliance is to be connected to the water mains using new hose sets and that old hose-sets should not be reused.
- The maximum number of place settings to be washed is 6.
- The maximum permissible inlet water pressure is 1MPa.
- The minimum permissible inlet water pressure is 0.04MPa.

2. Disposal

Dispose of the dishwasher packaging material correctly.
All packaging materials can be recycled.

Plastic parts are marked with the standard international abbreviations:

- PE — for polyethylene, e.g. sheet wrapping material
- PS — for polystyrene, e.g. padding material
- POM — polyoxymethylene, e.g. plastic clips
- PP — polypropylene, e.g. Salt filler
- ABS — Acrylonitrile Butadiene Styrene, e.g. Control Panel .



WARNING!

- Packaging material could be dangerous for children!
- For disposing of package and the appliance please go to a recycling centre. Therefore cut off the power supply cable and make the door closing device unusable.
- Cardboard packaging is manufactured from recycled paper and should be disposed in the waste paper collection for recycling.
- By ensuring this product is disposed of correctly, you will help prevent potential negative consequences for the environment and human health, which could otherwise be caused by inappropriate waste handling of this product.
- For more detailed information about recycling of this product, please contact your local city office and your household waste disposal service.
- **DISPOSAL:** Do not dispose this product as unsorted municipal waste. Collection of such waste separately for special treatment is necessary.

3. Operation Instruction

! IMPORTANT To get the best performance from your dishwasher, read all operating instructions before using it for the first time.

Control Panel

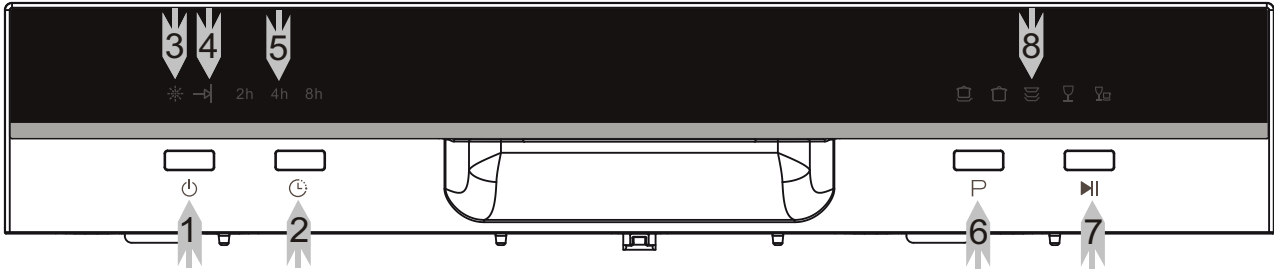

- 1** Power Button: To turn ON/OFF the power supply.
- 2** Delay Button: Press the button to delay the washing time.
- 3** Rinse Aid indicator *****: Indicates when the dispenser needs to be refilled.
- 4** Cycle Finish light **→|**: To show when the washing program is finished.
- 5** Delay time: 2/4/6/8 hours option. (6h: the 2h and 4h lights on at the same time).
- 6** Washing Program Selector: Press the button to select wash cycles.
- 7** Start/Pause Button: Press this button to start or pause the dishwasher working.
- 8** Program indicators:

Dishwasher Features

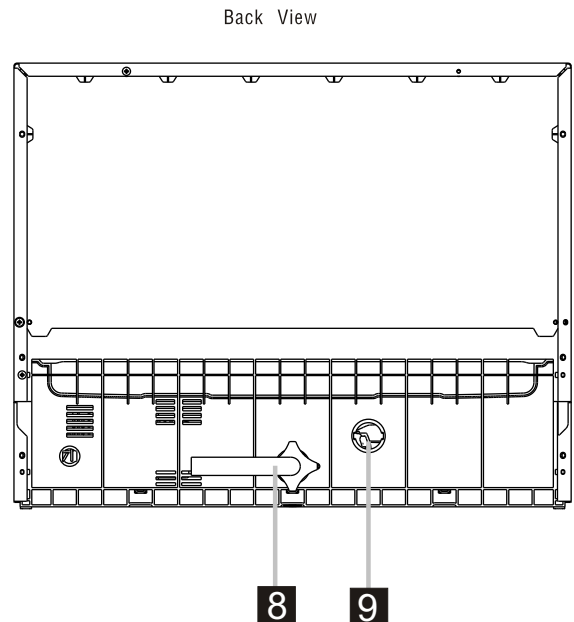
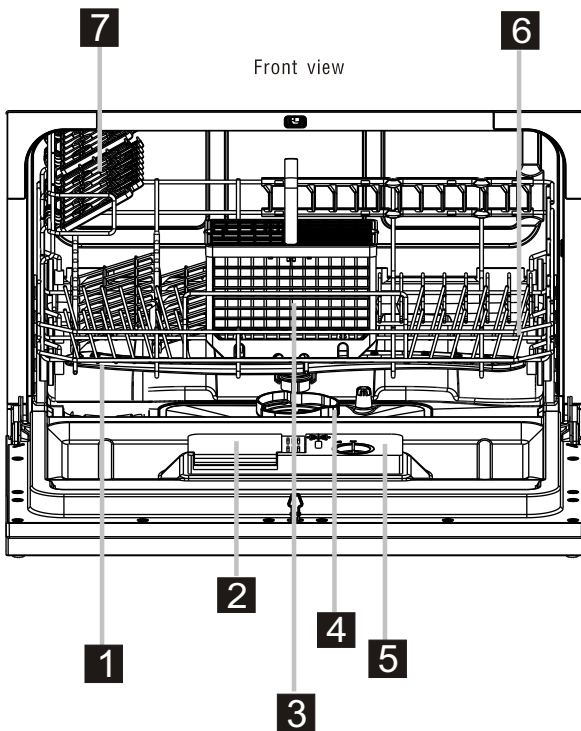

- | | | | | |
|------------------------------|--------------------------|------------------------------|-------------------------------|-------------------------------|
| 1 Spray Arms | 3 Cutlery Basket | 5 Rinse Aid Dispenser | 7 Cup Shelf | 9 Drain pipe connector |
| 2 Detergent Dispenser | 4 Filter assembly | 6 Basket | 8 Inlet pipe connector | |

4. Prior to using for the first time

A. Rinse Aid Dispenser

Rinse Aid Dispenser

The rinse aid is released during the final rinse to prevent water forming droplets on your dishes, which can leave spots and streaks. It also improves drying by allowing water to roll off the dishes. Your dishwasher is designed to use liquid rinse aids. The rinse aid dispenser is located inside the door next to the detergent dispenser. To fill the dispenser, open the cap and pour the rinse aid into the dispenser until the level indicator turns completely black. The volume of the rinse aid container is about 110ml.

Function of Rinse Aid

Rinse aid is automatically added during the last rinse, ensuring thorough rinsing, spot and streak free help the drying.

Attention!

Only use branded rinse aid for dishwasher. Never fill the rinse aid dispenser with any other substances (e.g. Dishwasher cleaning agent, liquid detergent). This would damage the appliance.

When to Refill the Rinse Aid Dispenser

If there is no rinse-aid warning light in the control panel, you can judge the amount of rinse-aid by the color of the optical level indicator "C" located next to the cap. When the rinse-aid container is full, the whole indicator will be dark. As the rinse-aid diminishes, the size of the dark dot decreases. You should never let the rinse aid get below 1 / 4 full.

As the rinse aid diminishes, the size of the black dot on the rinse aid level indicator changes, as illustrated below.

- Full
- ◐ 3 / 4 full
- ◑ 1 / 2 full
- ◒ 1 / 4 full - Should refill to eliminate spotting
- Empty

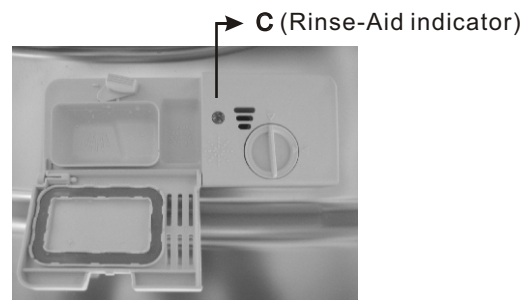

How to fill the Rinse Aid Dispenser



- 1** To open the dispenser, turn the cap to the "open" (left) arrow and lift it out.
- 2** Pour the rinse aid into the dispenser, being careful not to overfill.
- 3** Replace the cap by inserting it aligned with "open" arrow and turning it to the closed (right) arrow.

! NOTE: Clean up any rinse aid spilled during filling with an absorbent cloth to avoid excessive foaming during the next wash. Don't forget to replace the cap before you close dishwasher door.

Adjusting Rinse Aid Dispenser

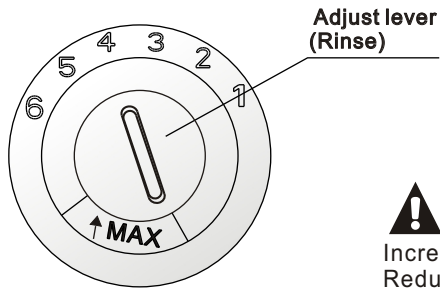

The rinse aid dispenser has six or four settings. Always start with the dispenser set on "4". If spots and poor drying are a problem, increase the amount of rinse aid dispensed by removing the dispenser lid and rotating the dial to "5". If the dishes still are not drying properly or are spotted, adjust the dial to the next higher number until your dishes are spot-free. The recommended setting is "4". (Factory value is "4".)

NOTE:

Increase the dose if there are drops of water or lime spots on the dishes after washing. Reduce it if there are sticky whitish stains on your dishes or a bluish film on glassware or knife blades.

B. Detergent

Detergents have chemical ingredients that are necessary to remove dirt, crush dirt and transport it out of the dishwasher. Most of the commercial quality detergents are suitable for this purpose.

Normally new pulverised detergent is without phosphate, thus the water softener function of phosphate is not given. If detergents without phosphate were used in case of hard water often white spots appear at dishes and glasses. In this case please add more detergent to reach better results. Detergents without chlorine do only bleach a little. Strong and coloured spots will not be removed completely. In this case please choose a program with higher temperature.

Concentrated Detergent

Based on their chemical composition, detergents can be split in two basic types:

- Conventional, alkaline detergents with caustic components.
- Low alkaline concentrated detergents with natural enzymes.

The use of Normal washing program in combination with concentrated detergent reduces pollution and is good for your dishes.

Detergent Tablets

Detergent tablets of different brands dissolve at different speeds. For this reason some detergent tablets cannot dissolve and develop their full cleaning power during short Program. Therefore please use long program when using detergent tablets, to ensure the complete removal of detergent residuals.

Detergent Dispenser

The dispenser must be refilled before the start of each wash cycle following the instructions provided in the Wash Cycle Table. Your dishwasher uses less detergent and rinse aid than conventional dishwasher. Generally, only one tablespoon of detergent is needed for a normal wash load. More heavily soiled items need more detergent. Always add the detergent just before starting the dishwasher, otherwise it could get damp and will not dissolve properly.

Adding detergent to dispenser

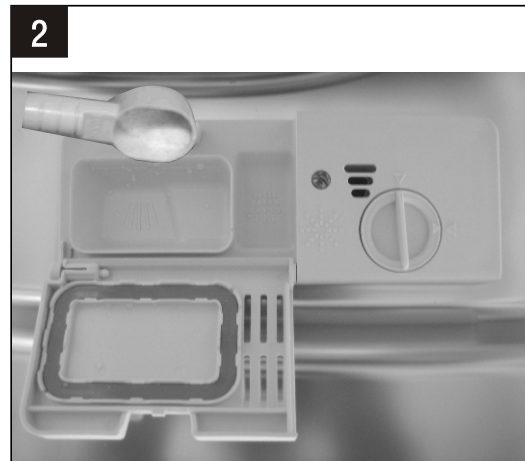
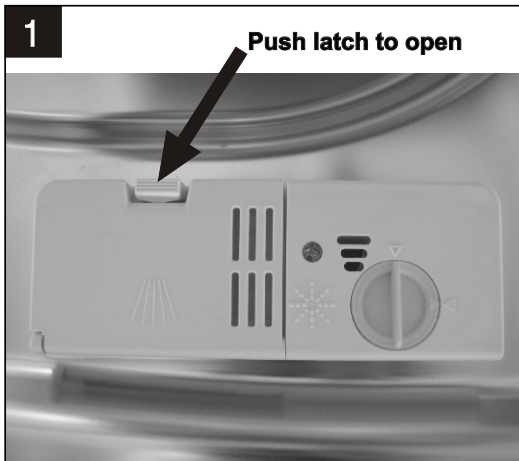

! NOTE:

- If the lid is closed: push the latch to open.
- Always add the detergent just before starting each wash cycle.
- Only use branded detergent and rinse aid for dishwasher.

! WARNING!

Dishwasher detergent is corrosive!
Take care to keep it out of reach of children.

Proper Use of Detergent

Use only detergents specifically made for use in dishwashers. Keep your detergent fresh and dry. Don't put powder detergent into the dispenser until you're ready to wash dishes.

Fill in detergent dispenser

Fill the detergent dispenser with detergent. The marking indicates the dosing levels, as illustrated on right:

- A** Location of main wash cycle detergent.
- B** Location of pre-wash cycle detergent.

Please observe the manufacturers dosing and storage Recommendations as stated on the detergent packaging.

Close the lid and press until it locks in place.

If the dishes are heavily soiled, place an additional detergent dose in the pre-wash detergent chamber. This detergent will take effect during the pre-wash phase.

! NOTE:

- The information about the amount of detergent for the single programme please refer to the Wash Cycle Table on the page 9.
- Please be aware that soiling levels and water hardness can effect wash results.
- Please observe the manufacturer's recommendations on the detergent packaging.

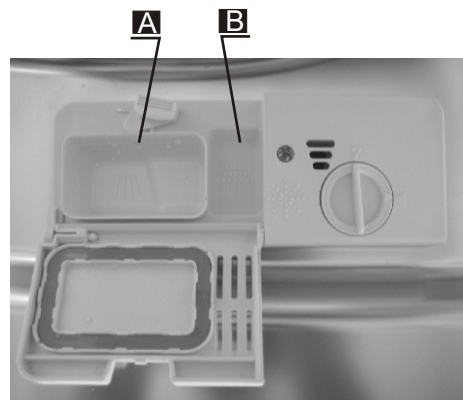

5. Loading the Dishwasher Baskets

Recommendation

- Consider buying utensils which are identified as dishwasher-proof.
- Use a mild detergent that is described as 'kind of dishes'. If necessary, seek further information from detergent manufacturers.
- For particular items, select a programme with as low a temperature.
- To prevent damage, do not take glass and cutlery out of the dishwasher immediately after the programme has ended.

Suitability of use in the dishwasher

Not suitable for use

- Cutlery with wooden, horn china or mother-of-pearl handles.
- Plastic items that are not heat resistant.
- Older cutlery with glued parts that is not temperature resistant.
- Bonded cutlery items or dishes.
- Pewter or copper items.
- Crystal glass.
- Steel items subject to rusting
- Wooden platters.
- Items made from synthetic fibres.

Limited suitability

- Some types of glasses can become dull after a large number of washes.
- Silver and aluminium parts have a tendency to discolour during washing.
- Glazed patterns may fade if machine washed frequently.

Attention before or after loading the Dishwasher Baskets

For the best performance of the dishwasher, follow these loading guidelines.
Features and appearance of baskets and cutlery baskets may vary from your model.

Scrape off any food particles. Soften remnants of burnt food in pans.
It is not necessary to rinse the dishes under running water.

Place objects in the dishwasher in following way:

1. Items such as cups, glasses, pots/pans, etc. are face downwards.
2. Curved items, or those with recesses, should be loaded at an angle so that water can run off.
3. All utensils are stacked securely and can not tip over.
4. All utensils are placed in the way that the spray arms can rotate freely during washing.









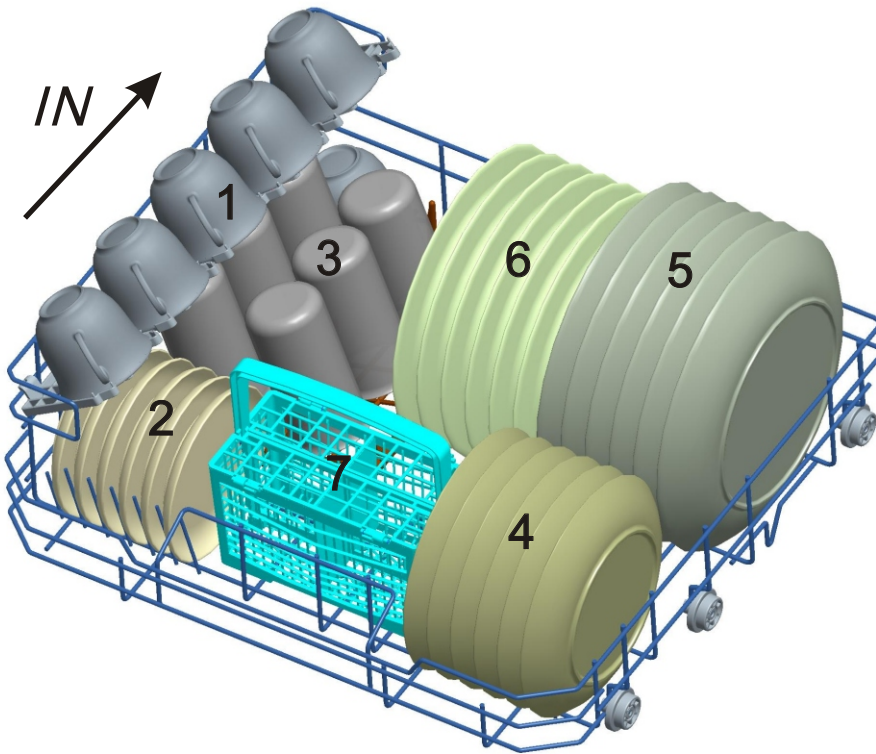

NOTE: Very small items should not be washed in the dishwasher as they could easily fall out of the basket.

- Load hollow items such as cups, glasses, pans etc, with the opening facing downwards so that water cannot collect in the container or a deep base.
- Dishes and items of cutlery must not lie inside one another, or cover each other.
- To avoid damage to glasses, they must not be touched.
- Long bladed knives stored in an upright position are a potential hazard!
- Long and/or sharp items of cutlery such as carving knives must be positioned horizontally in the basket.
- Please do not overload your dishwasher. This is important for good results and for reasonable energy consumption.

Loading the Basket

Position the dishes and cookware so that they do not get moved by the spray of water.





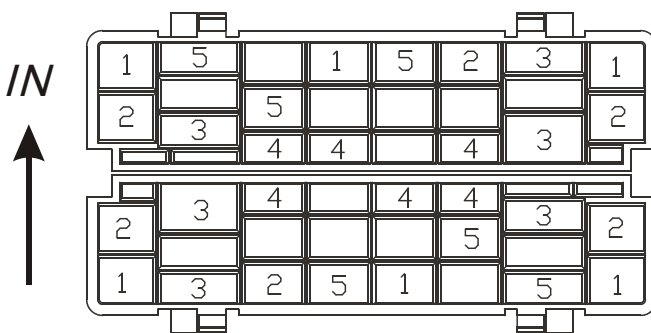

 1 Cups	 2 Saucers
 3 Glasses	 4 Dessert dishes
 5 Dinner plates	 6 Soup plates
 7 Cutlery basket	

Cutlery Basket

Cutlery should be placed into the cutlery basket with handles at the bottom.



1	Soup spoons	
2	Forks	
3	Knives	
4	Tea spoons	
5	Dessert spoons	



▲ WARNING!





- Do not let any item extend through bottom.
- Always load sharp utensils with the sharp point down!

For personal safety and a top quality clean, make sure place the silverware in the basket as follows:

- They do not stick together.
- Place silverware with handles-down.
- But place knives and other potentially dangerous utensils handles-up.

6. Starting a washing programme

Wash Cycle Table

Program	Cycle Selection Information	Description of Cycle	Detergent pre/main (tablet)	Running time(min)	Energy (Kwh)	Water (L)	Rinse Aid
Intensive 	For the heaviest soiled loads, such as pots, pans, casserole dishes and dishes that have been sitting with dried food on them for a while.	Pre-wash(50°C) Wash (55 °C) Rinse Rinse Rinse(70°C) Drying	5/17.5g (1or2 pieces)	140	0.85	9.7	★
Heavy 	For heavily soiled loads, such as pots, plates, glasses and lightly soiled pans.	Pre-wash Wash (60 °C) Rinse Rinse (70 °C) Drying	5/17.5g (1or2 pieces)	120	0.65	7.8	★
Normal  (*AS/NZS 2007.1)	For normally soiled loads, such as pots, plates, glasses and lightly soiled pans. standard daily cycle.	Pre-wash Wash (47°C) Rinse Rinse(50°C) Drying	5/17.5g (1 pieces)	135	0.45	7.4	★
Glass 	For lightly soiled loads, such as glasses, crystal and fine china.	wash(45°C) Rinse Rinse(60°C) Drying	22.5g (1 pieces)	70	0.45	6	★
Rapid 	A shorter wash for lightly soiled loads that do not need drying.	Wash (40 °C) Rinse Rinse	15g	30	0.32	5.8	

NOTE:

- (★) Means: need to fill rinse aid into the Rinse-Aid Dispenser.

*AS/NZS 2007.1 : This program is the test cycle. The information for comparability test in accordance with AS/NZS 2007.1, as follows:

- Capacity: 6 setting
- Rinse aid setting: 6
- Open the door slightly 50mm to assist in drying of the dishes after every wash

Turning On the Appliance

Starting a wash cycle

1. Draw out the basket(see the section entitled “Loading the Dishwasher basket”).
2. Pour in the detergent(see the section entitled “ Detergent and Rinse Aid”).
3. Insert the plug into the socket. The power supply is 220-240 VAC 50 Hz, the specification of the socket is 10 A250 VAC.
4. Make sure that the water supply is turned on to full pressure.
5. Press the program button, the wash program will be changed as following direction:
Normal->Glass->Rapid->Intensive->Heavy->Normal;
If a program is selected, the corresponding light will be on. Then press the Start/Pause button, the dishwasher begins to start.

NOTE:

When you press the Start/Pause button to pause during washing, the program light will stop blinking and the dishwasher will sound every minute unless you press the Start/Pause button to start.

Change the Program

You can modify the washing program, If the dishwasher just worked for a short time. Otherwise, the detergent may have already been released, and the appliance may have already drained the wash water. In this case, the detergent dispenser must be refilled (see the section entitled "Detergent").

Press Start/Pause Button more than three seconds the machine will be in stand by state, then you can change the program to the desired cycle setting (see the section entitled " Starting a wash program).

The program lights show the status of the dishwasher:

- a) One of the program lights on-----stand by or pause.
- b) One of the program lights blinking----- running.

 **NOTE:** If you open the door during washing, the machine will pause. When you close the door and press the start/reset Button, the machine will keep on working after 10 seconds.

Forget to Add a Dish?

A forgotten dish can be added any time before the detergent cup opens.

- 1** Press the start/pause button.
- 2** Open the door a little to stop the washing.
- 3** After the spray arms stop working, you can open the door completely.
- 4** Add forgotten dishes.
- 5** Close the door.
- 6** Press the start/pause button, the dishwasher will run after 10 seconds.

At the end of the Wash Cycle

When the working cycle has finished, the buzzer of dishwasher will sound 8 seconds, then stop. Turn off the appliance using the Power button, shut off the water supply and open the door of the dishwasher. Wait a few minutes before unloading the dishwasher to avoid scald, the dishes and utensils are still hot and more susceptible to breakage. They will also dry better.

■ Switch Off the Dishwasher

1. Switch off the dishwasher by pressing the Power button.
2. Turn off the water tap.

■ Open the door carefully.

Hot dishes are sensitive to knocks. The dishes should be allowed to cool down around 15 minutes before removing from the appliance.

Open the dishwasher's door, leave it ajar and wait a few minutes before removing the dishes. In this way they will be cooler and the drying will be improved.

■ Unloading the dishwasher

It is normal that the dishwasher is wet inside.

WARNING!

It is dangerous to open the door when washing, because the hot water may scald you.

7. Maintenance and Cleaning

Filtering System

The filter prevent larger remnants of food or other objects from getting inside the pump.

The filter system consists of a coarse filter, a flat (Main filter) and a micro filter (fine filter).

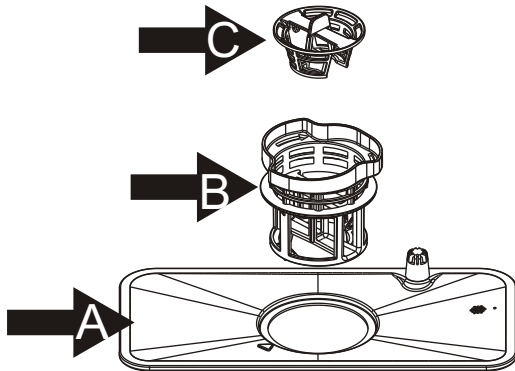

Main filter **A**

Food and soil particles trapped by this filter are pulverized by a special jet on the spray arm and washed down to drain.

Fine filter **B**

This filter holds soil and food residues in the sump area and prevents it from being redeposited on the dishes during a cycle.

Coarse filter **C**

Larger items, such as pieces of bone or glass, that could block the drain are trapped in the coarse filter. To remove the items caught by this filter, gently squeeze the tap on the top of this filter and lift it out.

Filter assembly

The filter efficiently removes food particles from the wash water, allowing it to be recycled during the cycle. For best performance and results, the filter assembly must be cleaned regularly. For this reason, it is a good idea to remove the larger food particles trapping in the filter after each wash cycle by rinsing the filter and cup under running water. To remove the filter assembly, pull the cup handle in the upward direction.

⚠ WARNING!

Never run the dishwasher without the filters in place. The dishwasher must never be used without the filters. Improper replacement of the filter may reduce the performance level of the appliance and damage dishes and utensils.

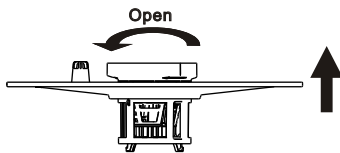

Step 1: Contrarotate the filter assembly (A, B and C), then lift it all up.

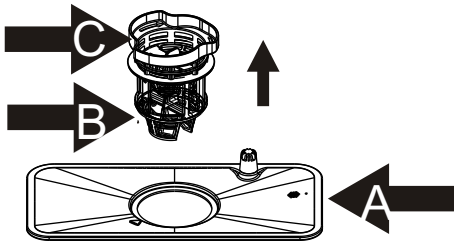

Step 2: Lift B and C up from A.

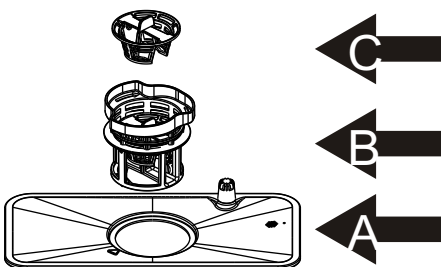

Step 3: Separate B and C.

⚠ NOTE: If do it from step 1 to step 3, the filter system will be removed; while if do it from step 3 to step 1, the filter system will be installed.

Notes:

- Inspect the filters for blocking after every time the dishwasher has been used.
- By unscrewing the coarse filter, you can remove the filter system. Remove any food remnants and clean the filters under running water.

! NOTE: The entire filter assembly should be cleaned once a week.

Cleaning The Filter

To clean the coarse filter and the fine filter, use a cleaning brush. Reassemble the filter parts as shown in the figures on the last page and reinsert the entire assembly in the dishwasher, positioning in its seat and pressing downward.

! WARNING! When cleaning the filters, don't knock on them. Otherwise, the filters could be contorted and the performance of dishwasher could be decreased.

Caring for the Dishwasher

The control panel can be cleaned by using a lightly dampened cloth. After cleaning, make sure to dry it thoroughly. For the exterior, use a good appliance polish wax. Never use sharp objects, scouring pads or harsh cleaners on any part of the dishwasher.

Cleaning The Door

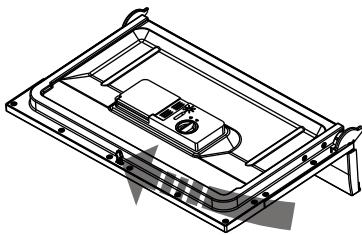

To clean the edge around the door, you should use only a soft warm, damp cloth. To avoid penetration of water into the door lock and electrical components, do not use a spray cleaner of any kind.

! WARNING!

Never use a spray cleaner to clean the door panel as it may damage the door lock and electrical components. Abrasive agents or some paper towel should not be used because of the risk of scratching or leaving spots on the stainless steel surface.

Protect Against Freezing

please take frost protection measures on the dishwasher in winter. Each time after washing cycles, please operate as follows:

1. Cut off electrical power to the dishwasher.
2. Turn off the water supply and disconnect the water inlet pipe from the water valve.
3. Drain water from the inlet pipe and water valve (Use a pan to catch the water).
4. Reconnect the water inlet pipe to the water valve.
5. Remove the filter at the bottom of the tub and use a sponge to soak up water in the sump.

! NOTE: If your dishwasher cannot work because of the ice, please contact authorised service persons.

Cleaning the Spray Arms

The spray arms can be easily removed for periodic cleaning of the nozzles to prevent possible clogging. Wash them under running water and carefully replace them in their seats, checking that their rotary movement is in no way impeded.

Grasp the middle of the spray arm, pull it upwards to remove it. Wash the arm under a jet of running water and replace it carefully to its seat. After reassembly, check that the spray arms rotate freely. Otherwise, check that they have been installed correctly.

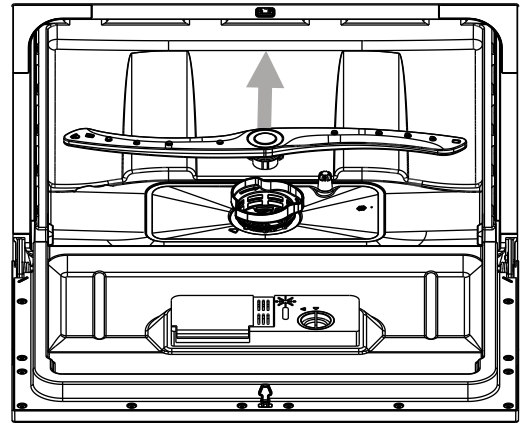

How to Keep Your Dishwasher in Shape

■ After Every Wash

After every wash, turn off the water supply to the appliance and leave the door slightly open so that moisture and odors are not trapped inside.

■ Remove the Plug

Before cleaning or performing maintenance, always remove the plug from the socket.

■ No Solvents or Abrasive Cleaning

To clean the exterior and rubber parts of the dishwasher, do not use solvents or abrasive cleaning products. Only use a cloth with warm soapy water. To remove spots or stains from the surface of the interior, use a cloth dampened with water with a little vinegar, or a cleaning product made specifically for dishwashers.

■ When not in use for a long time

It is recommended that you run a wash cycle with the dishwasher empty and then remove the plug from the socket, turn off the water supply and leave the door of the appliance slightly open. This will help the door seals to last longer and prevent odors from forming within the appliance.

■ Moving the Appliance

If the appliance must be moved, try to keep it in the vertical position. If absolutely necessary, it can be positioned on its back.

■ Seals

One of the factors that cause odors to form in the dishwasher is food that remains trapped in the seals. Periodic cleaning with a damp sponge will prevent this from occurring.

8. Installation instruction

Attention:

The installation of the pipes and electrical equipments should be done by qualified professionals.

Warning

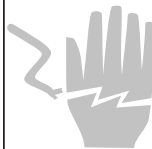

Electrical Shock Hazard
Disconnect electrical power before installing dishwasher.

Failure to do so can result in death or electrical shock.

Installation preparation

The installation position of dishwasher should be near the existing water inlet tap and drain outlet and power socket.

One side of the cabinet sink should be chosen to facilitate the connection of drain hoses of the dishwasher.

Positioning the Appliance

Position the appliance in the desired location. The back should rest against the wall behind it, and the sides, along the adjacent cabinets or wall. The dishwasher is equipped with water supply and drain hoses that can be positioned to the right or the left to facilitate proper installation.

About Power Connection

⚠ WARNING!

For personal safety:

Do not use an extension cord or an adapter plug with this appliance.

Do not cut or remove the earthing under any circumstances.

Connection from the power cord.

Electrical Requirements

Please look at the rating label to know the rating voltage and connect the dishwasher to the appropriate power supply. Use the required fuse 10 amp, time delay fuse or circuit breaker recommended and provide separate circuit serving only this appliance.

Electrical Connection

⚠ Insure proper ground exists before use

Ensure the voltage and frequency of the power being corresponds to those on the rating plate. Only insert the plug into an electrical socket which is earthed properly. If the electrical socket to which the appliance must be connected is not appropriate for the plug, replace the socket, rather than using a adaptors or the like as they could cause overheating and burns.

Water Connection

Cold Water Connection

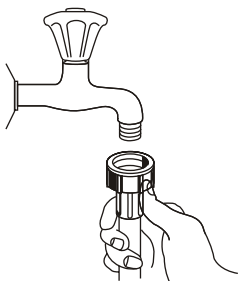

Connect the cold water supply hose to a threaded 3/4(inch) connector and make sure that it is fastened tightly in place. If the water pipes are new or have not been used for an extended period of time, let the water run to make sure that the water is clear and free of impurities. If this precaution is not taken, there is a risk that the water inlet can get blocked and damage the appliance.

Please note: If the supplied hose does not fit your tap, please contact your local plumbing supply center where adapters are available for purchase.

⚠ WARNING! please close the hydrant after using.

Connection of drain hoses

Insert the drain hose into a drain pipe with a minimum diameter of 4cm, or let it run into the sink, making sure to avoid bending or crimping it. The free end of the hose must be at a height lower than 30 cm and must not be immersed into water to avoid the backflow of it.

NOTE

The top of the hose must be less than 300mm.

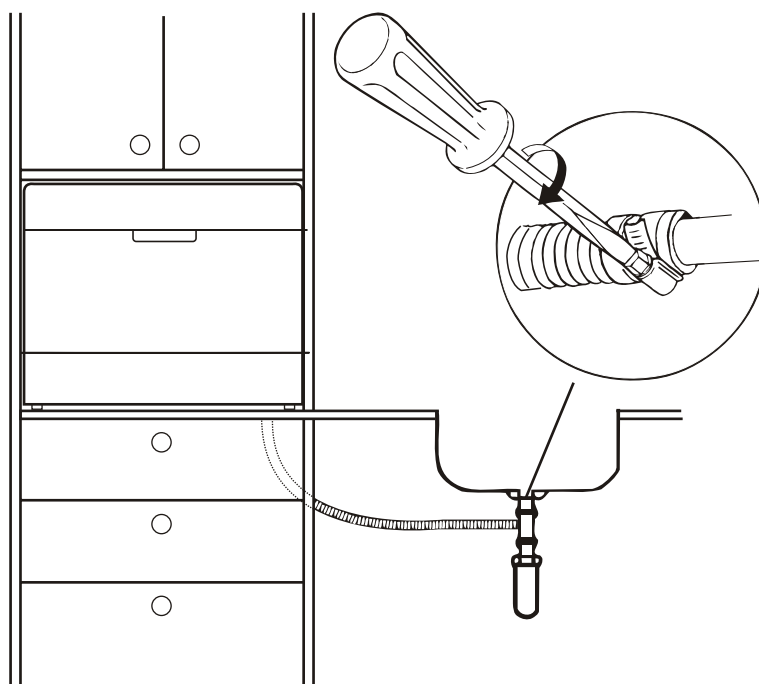
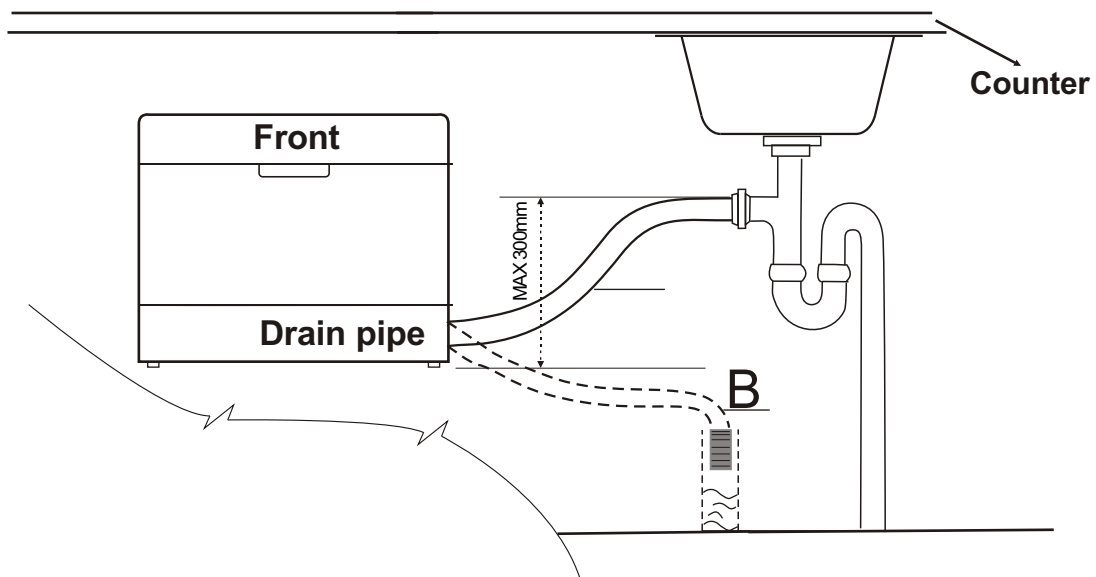

How to Drain Excess Water From Hoses

If the sink is more than 1000mm higher than the floor, the excess water in hoses cannot be drained directly into the sink. It will be necessary to drain excess water from hoses into a bowl or suitable container that is held outside and lower than the sink.

Water Outlet

Connect the water drain hose. The drain hose must be correctly fitted to avoid water leaks. Ensure that the water drain hose is not kinked or squashed.

Extension Hose

If you need a drain hose extension, make sure to use a similar drain hose. It must be no longer than 4 metres, otherwise the cleaning effect of the dishwasher could be reduced.

Start of dishwasher

The following things should be checked before starting the dishwasher.

- 1** The dishwasher is level and fixed properly.
- 2** The inlet valve is open.
- 3** There is no leakage at the connections of the conducts.
- 4** The wires are tightly connected.
- 5** The power is switched on.
- 6** The inlet and drain hoses are not knotted and kinked.
- 7** All packing and printing materials should be taken out of the dishwasher.



Attention: *After installation, please make sure to keep this manual.*

The content of this manual is very helpful to the users.

9. Troubleshooting Tips

Before Mailing for Service

Review the charts on the following pages may save you from mailing for service.



	<i>Problem</i>	<i>Possible Causes</i>	<i>What To Do</i>
Technical problems	<i>Dishwasher doesn't start</i>	Fuse blown, or the circuit breaker triggered.	Replace fuse or reset circuit breaker. Remove any other appliances sharing the same circuit with the dishwasher.
		Power supply is not turned on.	Make sure the dishwasher is turned on and the door is closed securely. Make sure the power cord is properly plugged into the wall socket.
		Door of dishwasher not properly closed.	Make sure to close the door property and latch it.
General problems	<i>Water not pumped from dishwasher</i>	Kink in drain hose	Check drain hose.
		Filter clogged.	Check the coarse filter. (see section titled "Cleaning The Filter")
		Kitchen sink clogged.	Check kitchen sink to make sure it is draining well. If the problem is the kitchen sink not draining, you may need a plumber rather than a serviceman for dishwasher.
	<i>Suds in the tub</i>	Improper detergent	Use only the special dishwasher detergent to avoid suds. If this occurred, open the dishwasher and let suds evaporate. Add 1 gallon of cold water to the tub. Close and latch the dishwasher, then Start any wash cycle to drain out the water. Repeat if necessary.
		Spilled rinse-aid	Always wipe up rinse-aid spills immediately.
<i>Stained tub interior</i>	Detergent with colourant was used.	Make sure that the detergent is the one without colourant.	
<i>White film on inside surface</i>	Hard water minerals	To clean the interior, use a damp sponge with dishwasher detergent and wear rubber gloves. Never use any other cleaner than dishwasher detergent for the risk of foaming or suds.	
<i>There are rust stains on cutlery</i>	The affected items are not corrosion resistant.	The items should be corrosion resitant.	
Noise	<i>Knocking noise in the wash cabinet</i>	The spray arm is knocking against an item in a basket.	Interrupt the programme, and rearrange the items which are obstructing the spray arm.
	<i>Rattling noise in the wash cabinet</i>	Item of crockery are loose in the wash cabinet.	Interrupt the program, and rearrange the items of crockery.
	<i>Knocking noise in the water pipes</i>	This may be caused by on-site installation or the cross-section of the piping.	This has no influence on dishwasher function. if in doubt, contact a suitably qualified plumber.



Unsatis-
-factory
washing
result

<i>Problem</i>	<i>Possible Causes</i>	<i>What To Do</i>
<i>The dishes are not clean</i>	The dishes were not loaded correctly.	See notes in " Loading the Dishwasher Baskets ".
	The program was not powerful enough.	Select a more intensive programme. See" Wash Cycle Table ".
	Not enough detergent was dispensed.	Use more detergent, or change your detergent.
	Items are blocking the path of spray arms.	Rearrange the items so that the sprayer can rotate freely.
	The filter combination is not clean or is not correctly fitted. This may cause the spray arm jets get blocked.	Clean and/or fit the filter combination correctly. Clean the spray arm jets. See "Cleaning the Spray Arms".
<i>Cloudiness on glassware</i>	Combination of soft water and too much detergent.	Use less detergent if you have soft water and select a shortest cycle to wash the glassware and to get them clean.
<i>Black or gray marks on dishes</i>	Aluminum utensils have rubbed against dishes.	Use a mild abrasive cleaner to eliminate those marks.
<i>Detergent left in dispenser cups</i>	Dishes block detergent cups opens.	Re-loading the dishes properly.

Unsatis-
-factory
drying
result

<i>The dishes are not drying</i>	Improper loading	Load the dishwasher as suggested in the directions.
	Too little rinse-aid	Increase the amount of rinse-aid/Refill the rinse-aid dispenser.
	Dishes are removed too soon.	Do not empty your dishwasher immediately after washing. Open the door slightly so that the steam can escape. Begin unloading the dishwasher only once the dishes are barely warm by touching.
	Wrong program selection	In short program the rinse temperature is lower. Choose a program with a high rinse temperature.
	Using cutlery with a low-quality coating	Water drainage is more difficult with these items. Cutlery or dishes of this type are not suitable for washing in the dishwasher.

Error Codes

When some malfunctions occur, the appliance will display error codes to warn you:

<i>Codes</i>	<i>Meanings</i>	<i>Possible Causes</i>
<i>The Rapid light flicker fleetly</i>	Longer inlet time.	Faucet is not opened, or water intake is restricted, or water pressure is too low.
<i>The Nromal light flicker fleetly</i>	Overflow.	Some element of dishwasher leaks.

⚠ WARNING!

If overflow occurs, turn off the main water supply before mailing a service. If there is water in the base pan because of an overfill or small leak, the water should be removed before restarting the dishwasher.

Technical Information

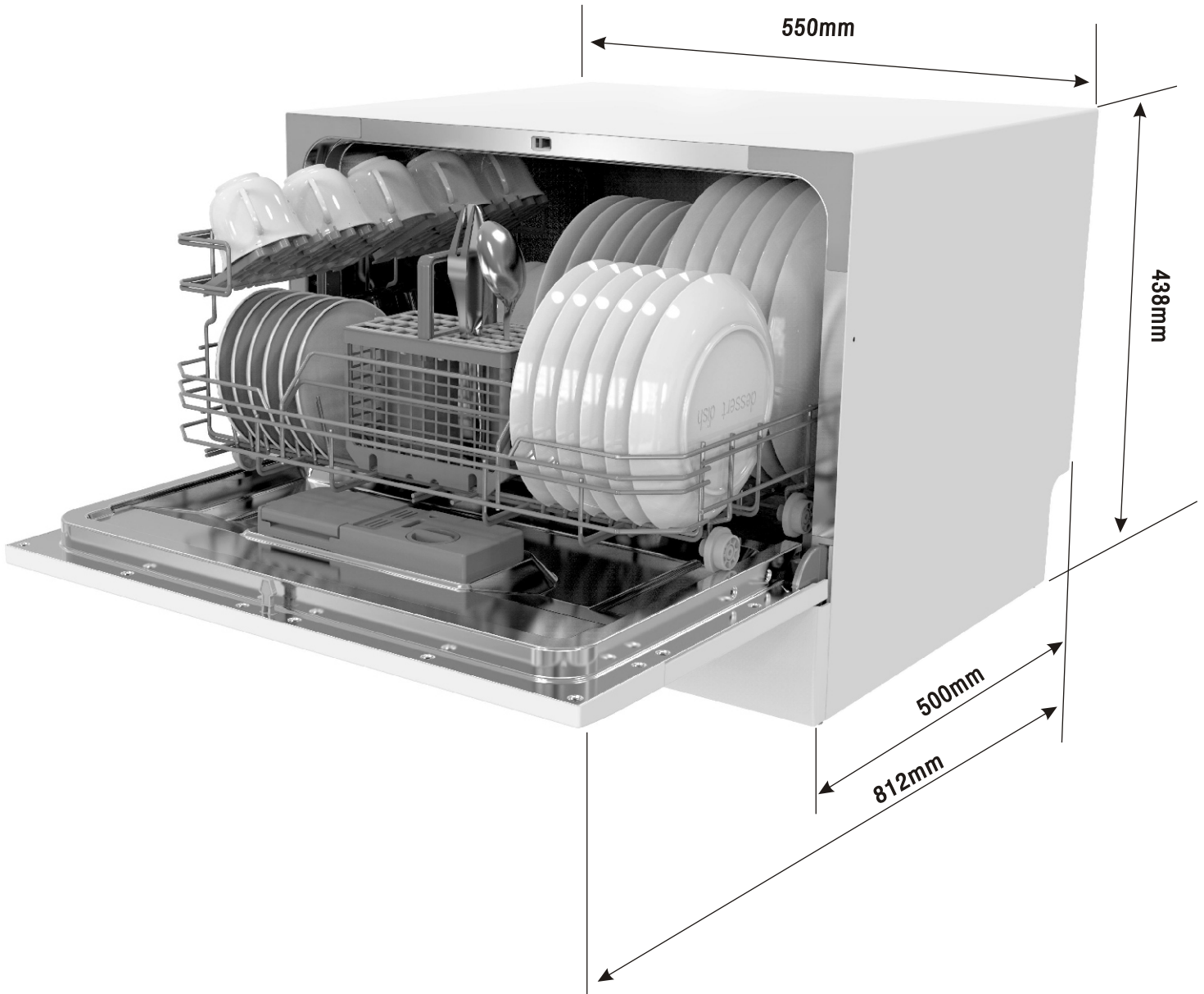

Height:	438mm
Width:	550mm
Depth:	500mm
Voltage connected Load:	see rating label
Water pressure:	0.04-1.0MPa
Power supply:	see rating label
Capacity:	6 Place settings