

DEVANTI®

INSTRUCTION MANUAL



Electric Oven

Model No.: ECO-B-NHP-45L-BK, ECO-B-NHP-60L-BK

Please read the manual carefully before operation

IMPORTANT SAFEGUARDS

1. When using this electric oven, basic precautions should always be followed, included the followings:
2. Read all instructions.
3. Do not touch hot surface, use handles and knobs.
4. Close supervision is necessary when any appliance is used by or near children.
5. To protect against electric shock, do not immerse cord, plug or any parts of the oven in water or other liquids.
6. Do not let cord hang over edge of table or counter, or touch hot surface.
7. Do not operate appliances with damaged cord or plug or after the appliance malfunctions, or have been damaged in any manner. Return the appliance to the nearest authorized service center for examination, repair, or adjustment.
8. Do not use other mismatched accessory, it may cause hazard or injury.
9. Do not place on or near a hot gas or electric burner, or in a heated oven or in a microware oven.
10. When operating the oven keep at least 4 inches of space on all sides of the oven to allow for adequate air circulation.
11. Unplug from outlet when not in use and before cleaning. Allow to cool before putting on or taking off parts, and before cleaning.
12. To disconnect, turn the timer control knob to OFF position, then remove the plug. Always hold the plug, but never pull the cord.
13. Extreme cautions must be used when moving an appliance containing hot oil or other hot liquid.
14. Do not use metal to touch any part of oven when operating.
15. Be extreme cautions when remove the tray or disposing of hot grease or other hot liquid.
16. Do not clean with metal scouring pads pieces can break off the pad and touch electric parts, creating a risk of electric shock.
17. Never leave the appliances unattended while broiling or toasting.
18. Oversized foods and metal utensils must not be inserted in the oven as they may create a fire or risk of electric shock.
19. A fire may cause if oven is covered or touching inflammable material, including curtains draperies, walls and like, when on operation, Do not store any item on the oven during operation.
20. Extreme caution should be exercised when using containers constructed of anything other than metal or glass.
21. Do not place any of the following materials on the oven: cardboard, plastic, paper or anything similar.
22. Do not store any materials, other than recommended accessories in the oven.
23. Always wear protective, insulated oven gloves or use the tray handle when inserting or removing any items from the hot oven. Allow for metal parts to cool down completely before cleaning.
24. This appliance is for household use only, do not use outdoor.
25. Do not use appliance for other than intended use.
26. This appliance can be used by children aged from 8 years and above and persons with reduced physical, sensory or mental capabilities or lack of experience and knowledge if they have been given supervision or instruction concerning use of the appliance in a safe way and understand the hazards involved.
27. Children shall not play with the appliance. Cleaning and user maintenance shall not be made by children without supervised.
28. If the supply cord is damaged, it must be replaced by the After-sales Service Center or a similarly qualified person in order to avoid a hazard.
29. Symbol  its meaning is: Caution, hot surface!
30. Caution: the oven is hot when working and after use. Do not touch.

PRODUCT SPECIFICATION

Model	ECO-B-NHP-45L-BK	ECO-B-NHP-60L-BK
Capacity	45L	60L
Voltage	220-240V~50/60Hz	220-240V~50/60Hz
Power	1800W	2000W
Function	Rotisserie, Convection, Inner Lamp	Rotisserie, Convection, Inner Lamp

PARTS OF APPLIANCE

- A: Housing
- B: Front panel
- C: Upper door clip
- D: Door handle
- E: Glass door
- F: Back plate
- G: Down door clip
- H: Oven foot
- I : Temperature control
- J: Heating elements control knob
- K: Rotisserie and convection control knob
- L: Timer
- M: Power indicator
- N: Rotisserie forks & handle
- O: Tray handle
- P: Bake rack
- Q: Bake tray

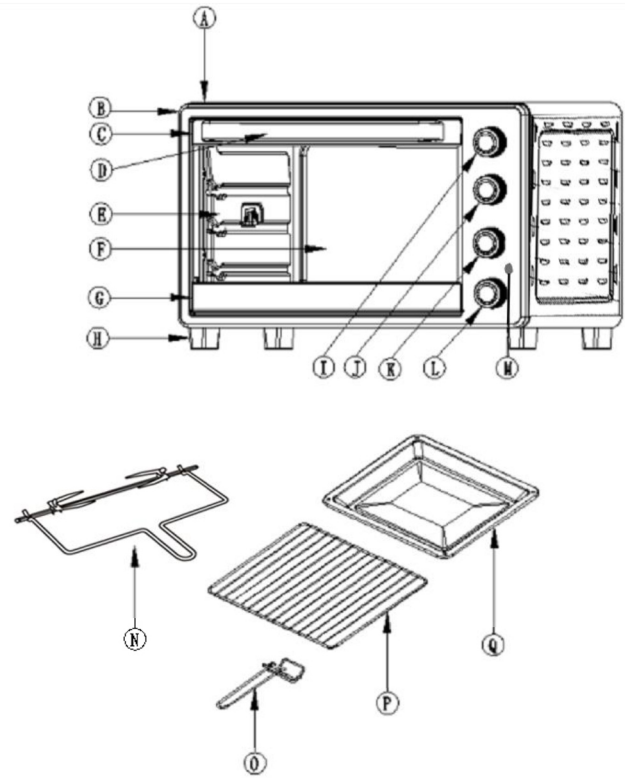

OPERATING INSTRUCTION

Before using your oven for the first time

Be sure to



1. Make sure that the oven is unplugged and the TIMER knob is on the OFF position.
2. Remove all the accessories and wash them in hot soak water or in the dishwasher.
3. Thoroughly dry all the accessories and re-assemble in oven. Plug the power cord into the wall socket and you are ready to use your oven.
4. After re-assembling your oven, we recommend that you run the oven at the max temperature for approximately 15 minutes to eliminate any dirty oil on its surface.
5. The oven may emit smoke with first time use under normal operating conditions and will soon disappear after 5 minute.

TEMPERATURE SETTING

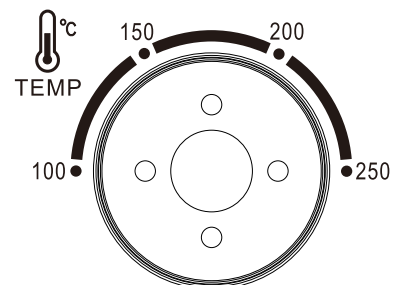
Turn the Temperature knob clockwise to the desired temperature setting.
The Temperature can be set from 100°C to 250°C



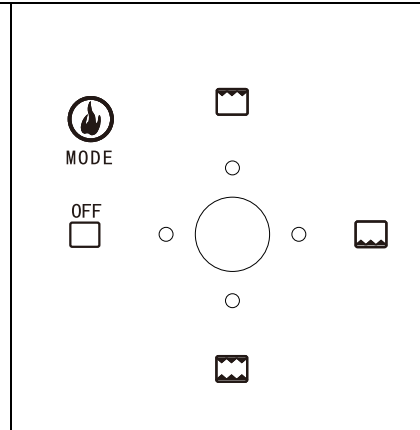

HEATING ELEMENTS CONTROL KNOB

1. Set the selector to “” upper heating position, upper heating elements work only.
2. Set the selector to “” down heating position, down heating elements work only.
3. Set the selector to “” up & down position, upper heating & down heating will be started together.
4. Set the “OFF” position at function knob, all functions are disabled;



ROTISSERIE AND CONVECTION CONTROL KNOB

1. Set the selector to “” ROTISSERIE position, and adjust the operation time at timer knob, then the rotisserie function will be started. Then set the desired baking function, grill temperature and time accordingly.
2. Set the selector to “” CONVECTION position, and adjust the operation time at timer knob, then the convection function will be started. Then set the desired baking function, grill temperature and time accordingly.
3. Set the selector to “” ROTISSERIE & CONVECTION position, and adjust the operation time at timer knob, convection & rotisserie function will be started together. Then set the desired baking function, grill temperature and time accordingly.

Set the “OFF” position at function knob, all functions are disabled.

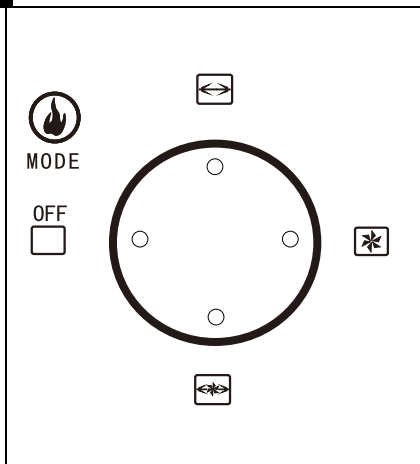

TIME SETTING

0-60 MINUTES: The Timer can be set up to 60 minutes. The oven will not turn on without the timer being set. When the Time knob is in the “OFF” position, the oven will not operate. To set the time, turn the knob clockwise to the desired time. Indicator Light is lit only when Time has been set. When the Timer has reached the OFF position, a bell sound will be heard. Power supply will be cut off automatically

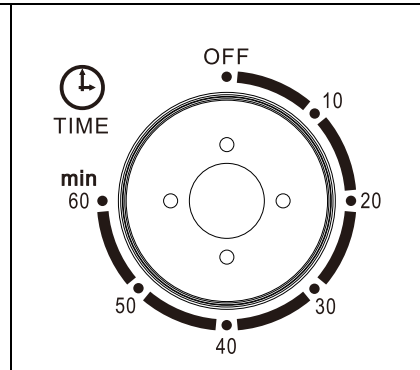

CLEANING

1. It is important that you clean the appliance after each use to prevent an accumulation of grease and avoid unpleasant odors.
2. The appliance must be cool down and unplug from outlet before cleaning.
3. Do not immerse appliance in water or wash it under waterspout.
4. Removable grill rack and bake tray can be washed, as normal kitchen ware.
5. Clean outer surface of appliance with damp cloth.
6. Do not use abrasive cleaner or sharp utensils to clean the oven, as scratching may weaker it and cause shattering.
7. Let all removable accessories and surfaces dry thoroughly prior to plugging oven in the wall socket.

SPECIAL WARNING:



Recycling symbol, don't dispose of the product with household refuse.

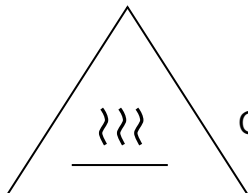

Caution: The temperature of the accessible surface may be high when the appliance is operating.