

Aroma Diffuser

User Manual

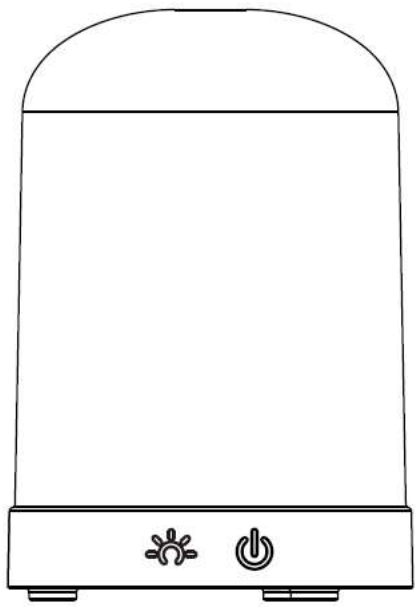

This aroma diffuser adopts ultrasonic technology to mist the water and essential oil, and to release the fresh fragrance.

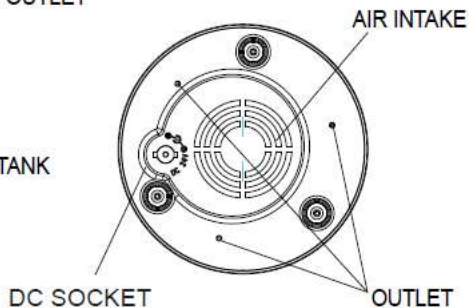
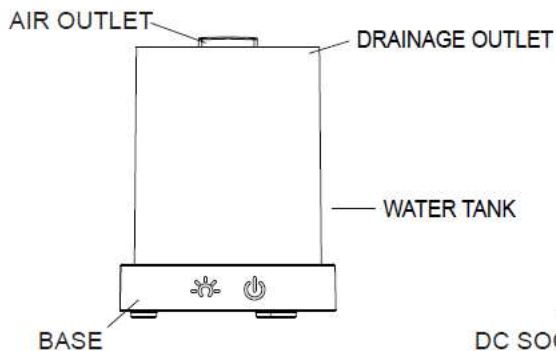
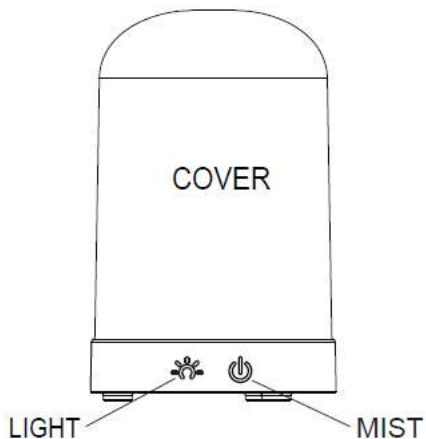



Instructions

When the diffuser works, the vertical transducer produces mist and the mist of essential oil diffuser. Ultrasonic vapor diffusing keeps the original effect of essential oils instead of heating or burning them. You can enjoy yourself in the natural fragrance of essential oil. You can use LED lights for night light, or decorative light.

Specifications

- 【 Type: 】 Ultrasonic Aroma Diffuser
- 【 Product Size: 】 $\Phi 92 \times 153$ (H)mm
- 【 Weight: 】 Approx 270g
- 【 Power supply: 】 Input/output AC100-240V 50/60Hz / DC24V/500mA
- 【 Power: 】 Approx 8W
- 【 Frequency: 】 2.4MHz ultrasonic
- 【 Water capacity: 】 160mL
- 【 Main material: 】 PP、 ABS
- 【 LED light: 】 4 pcs
- 【 Timer: 】 Working until waterless
- 【 Water lack protection: 】 Non-contact detection technology
- 【 Accessories: 】 Adapter, User Manual

Operation

1. Please put the product upside ,and remove the upper cover vertically. FIG1
2. Please connect the DC adapter to the DC socket of the product main body. FIG2
3. Pour the required amount of water into the tank,using the measuring cup provided,2-3 drops of essential oils should be added for 100ml of water. (Note:Pay attention to the filled water level:do not exceed the max line one the water tank.) FIG3
4. Install the cover of the main body with the original channel.
5. If you press the “” on,you can chose ON/OFF state of the LED light. Each click will lead to change the led light color. Pressing this button for a long time, turn off led light. FIG4
6. “” control the mist. Press this button or a long time, Mist OFF. FIG4
7. If there is litter water in the tank, the power supply will turn off immediately.
8. Please pour the water out of the tank if long time no use and keep it dry & clean.

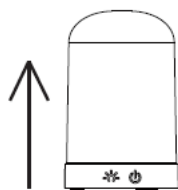

FIG 1

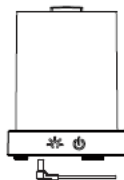

FIG 2

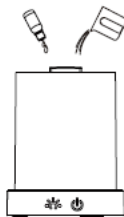

FIG 3

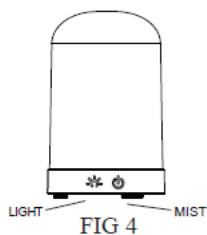

FIG 4

Maintenance

After using 5-6 times, or 3-5 days, please clean the product as follows.

- Unplug the unit from mains supply and remove cover.
- Pour out any remaining water from the “DRAIN SIDE” of the tank.
- Unplug power cord from base of unit.
- Put 1 tablespoon of citric acid in the water tank, add just under 100ml of warm water (up to 70°C)
- Leave for 5 minutes, and then drain solution from the “DRAIN SIDE” of the tank.
- Wipe with a soft cloth. Avoid Ultrasonic Vibration plate area, which can be gently cleaned with a cotton bud.

Never use other acids, enzymes or detergents, as this may risk poisonous gas to be created or cause malfunction.





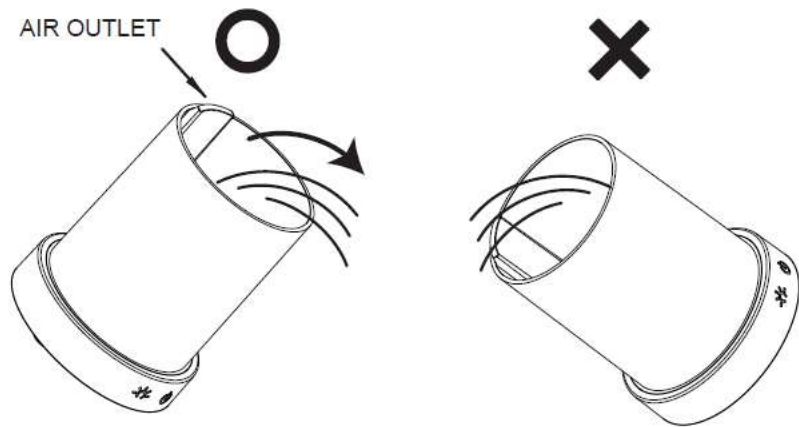





Cover has an inner cover that can also be removed for cleaning.

1. Pull grip as indicated in the diagram to release.
2. After cleaning inner cover, replace by holding grip, and pressing down inner and outer cover until “click” is heard.



Attention

In order to avoid to damage the product, please make sure the things are as follow:

- | | | | |
|--|---|--|--|
| 
Ban | Non-technical personnel shall not privately modification disassembly or repair this product. if you need service, please contact with sales department. | 
Ban | Don't stabbed, twisted, or stretched the line of the power adapter, don't place the electric wire to the high temperature place. |
| 
Ban | If the wire of the adapter was damage, or the socket was loose, please don't use the unit. | 
Ban | The unit should be placed in the flat position, don't put it in high altitude, slope,goods shelf or not steady places. |
| 
Ban | every time you use the product should drainage the water out of the water tank from the drain outlet side |  | Please use the neutral detergent to clean the product only |
| 
Ban | Please don't make the mist spraying directly to person in case of indrawing. | 
Ban | Please disconnect the adapter from the power cocket when you do the maintenance |
| 
Ban | Please do not put nails, needles and other debris at air outlet or the gap of main body. | 
Enforcement | Only the tap water, purified water is available. |



warning

As ignore signs, which leads to the improper operation, may cause harm to the user, and may damage the product

Our commitment:

If your purchase is defective or unsatisfactory,

PLEASE CONTACT US FIRST SO WE CAN SOLVE THE ISSUE.

We can send you a replacement on free or assist you with a full refund. No questions asked. Because your purchase is shipped from China there is a chance a problem during shipping may have happened.

We promised that we will provide at least 12 months warranty for our products.

Our company policy is to guarantee 100% satisfaction.

Thank you very much for your support and trust.